

## THE LITESTACK CHIMNEY RANGE

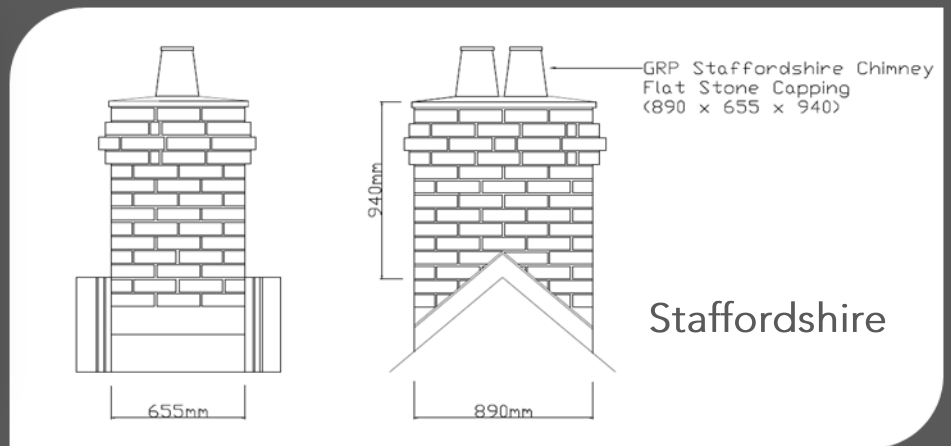

NOTE: All sizes are approximate.

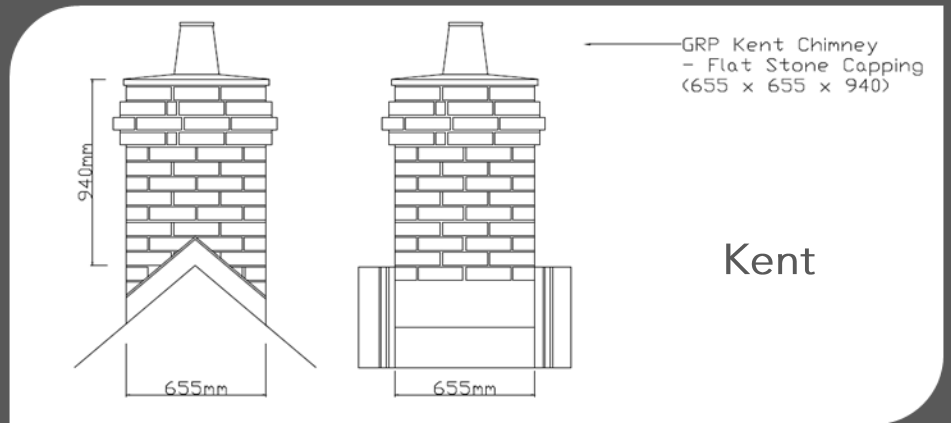
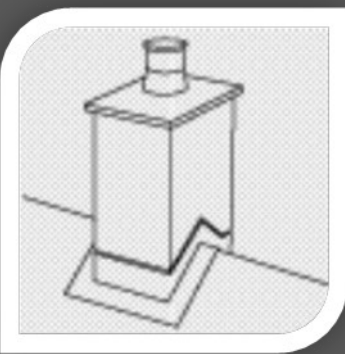

Mid—Ridge

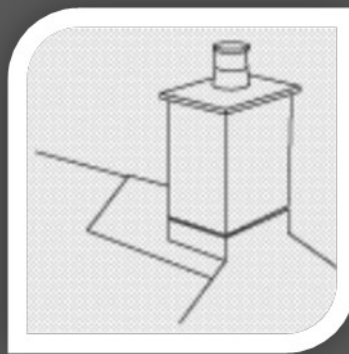

End—Ridge



Mono Picked

Litestack provides a range of complete chimney solutions, based on a ready to install one—piece chimney stack. Lightweight and very easy to use—the chimney is simply lifted into position, bolted onto the roof trusses and leaded in the normal way. Choose from brick, stone or render finish. Also available pre-leaded to save time and labour on-site and all models can be made functional with the addition of a Class 1 twin-walled flue system.

**THE LITESTACK CHIMNEY RANGE**

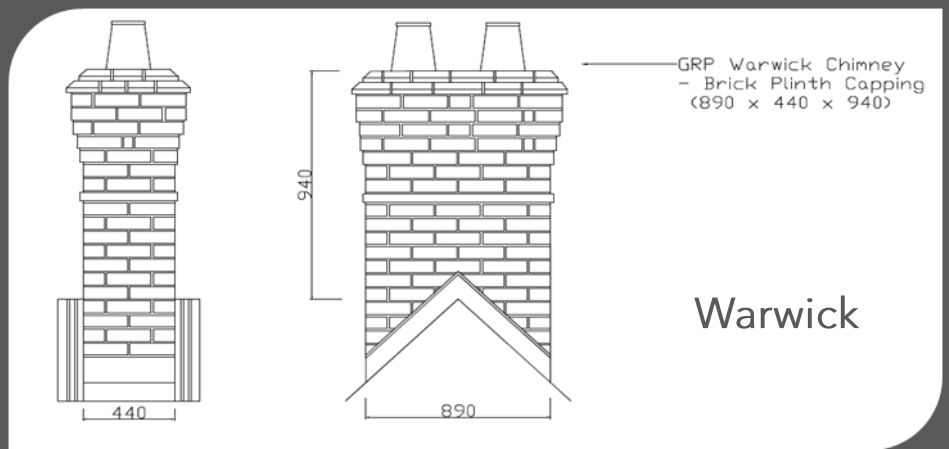
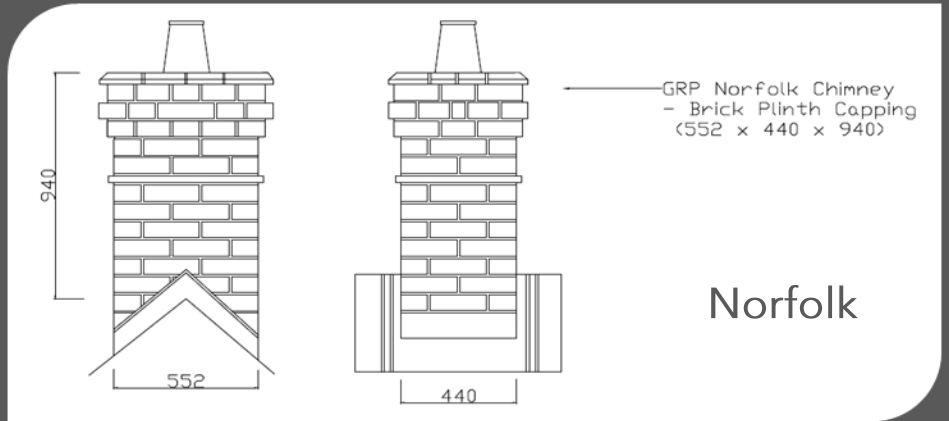

NOTE: All sizes are approximate.

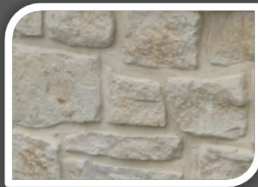

Natural Stone



Recon Stone



Smooth Render



Rough Render



Each Litestack Chimney is supplied with a fixing kit & detailed instructions. The units can be installed immediately after the rafters are in place, using a hoist, telehandler or light crane.

- Realistic
- Lightweight
- Cost Effective
- Strong & Weatherproof
- Quick, Easy Installation

